

Numération

14

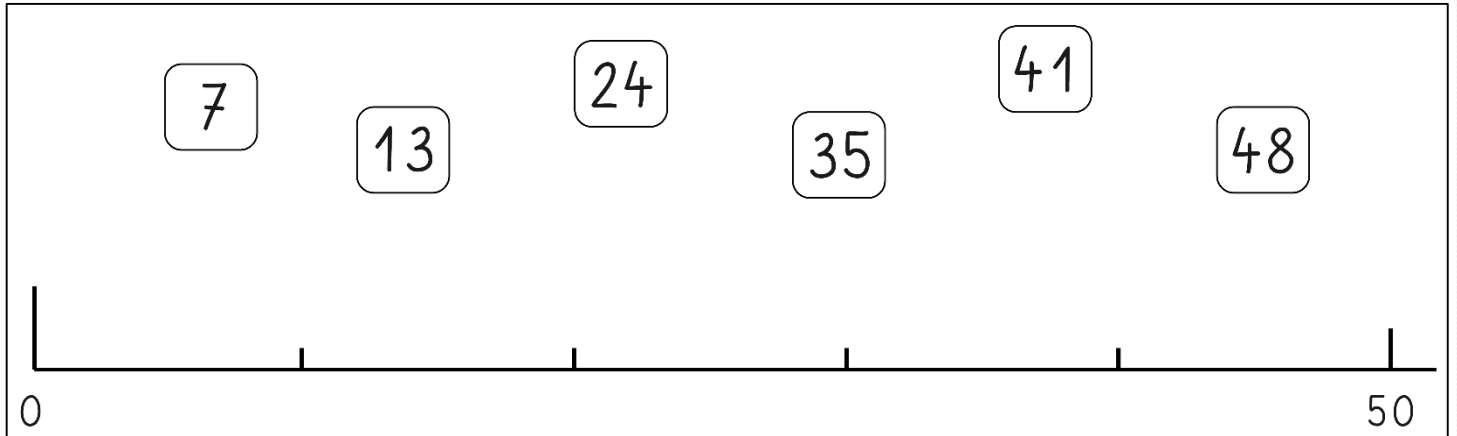

1 - Relie les nombres sur la file numérique :



2 - Ecris les nombres sur la file numérique :

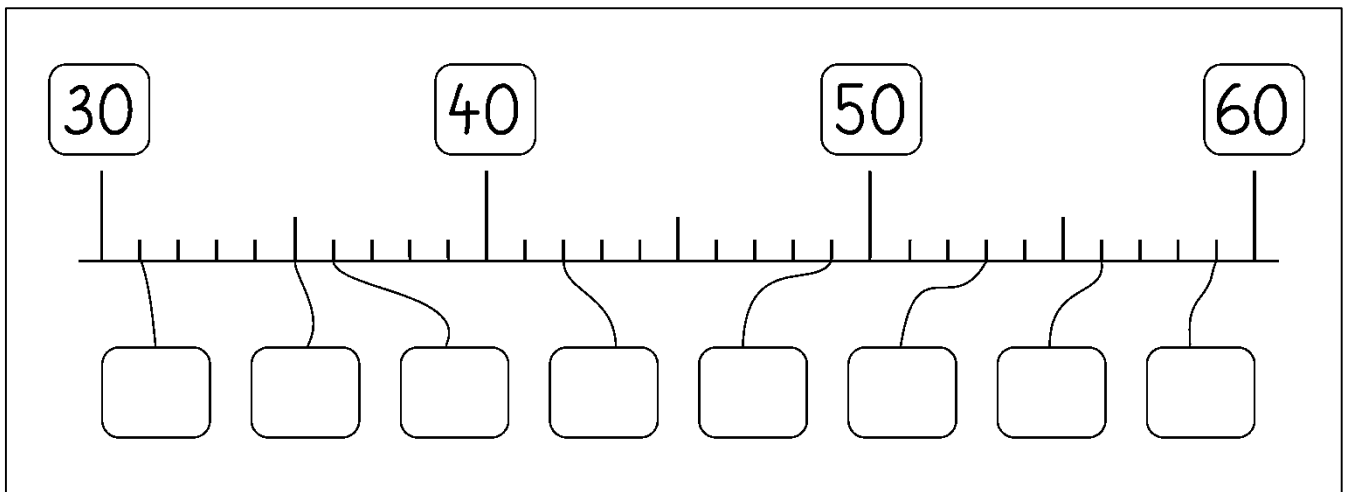

3 - Relie les nombres sur la file numérique :

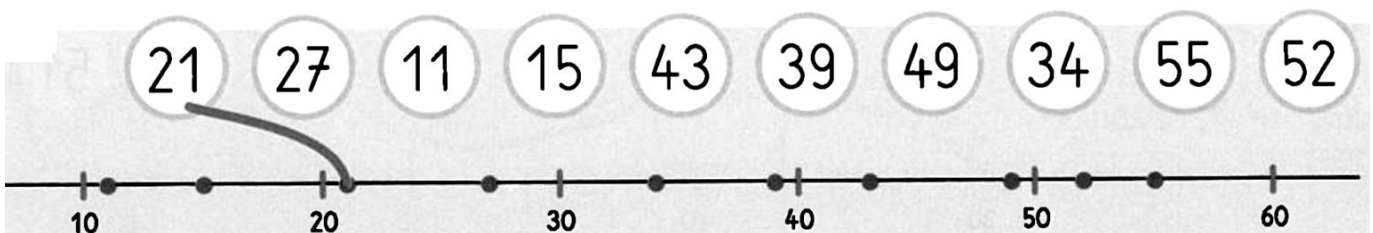

4 - Colorie le plus grand nombre dans chaque bocal :

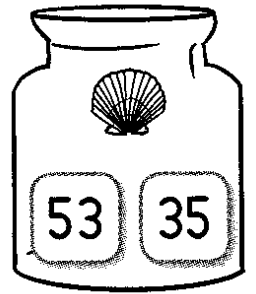
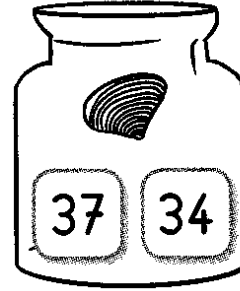
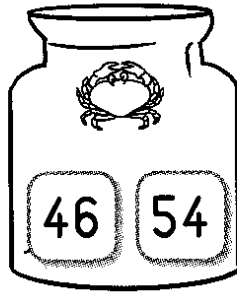
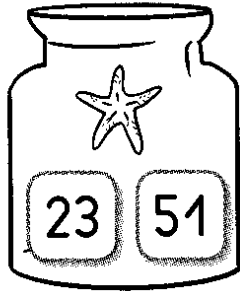
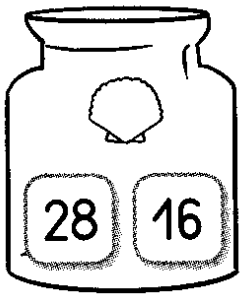

5 - Colorie les bougies qui conviennent :

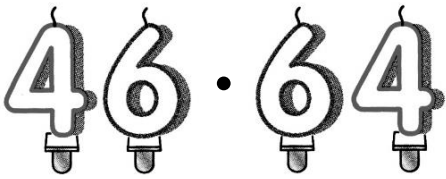

soixante-quatre ans

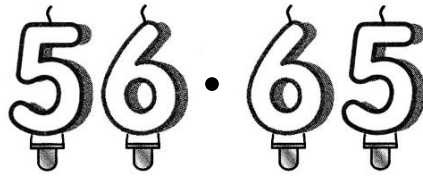

cinquante-six ans

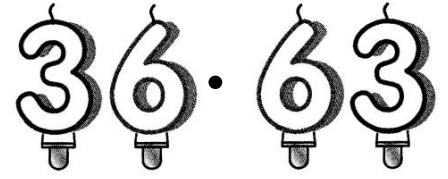

soixante-trois ans

6 - Ecris en lettres en t'aidant de ton sous-mains :

57

.....

61

.....

18

.....

45

.....

36

.....

26

.....

7 - Colorie les nombres identiques de la même couleur
(attention aux intrus !):

56

65

26

35

59

53

62

48

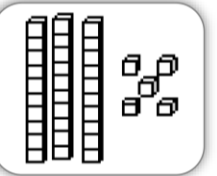
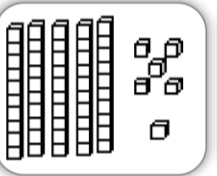
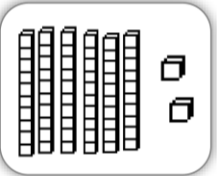
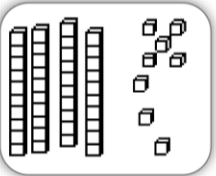
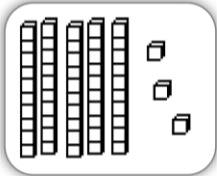
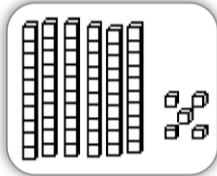

8 - Entoure les étoiles par dix, complète le tableau !

Compte les étoiles de mer et écris leur nombre.

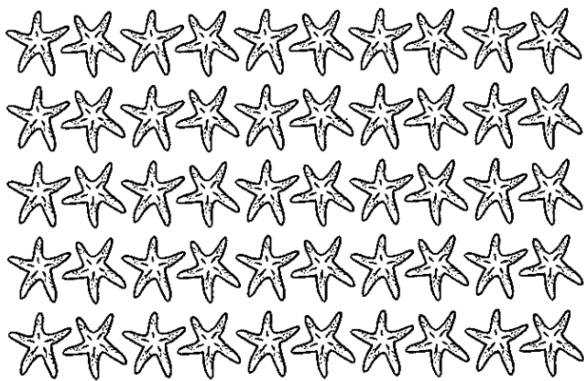

D	U



Il y a étoiles de mer.

9 - Colorie de la même couleur les doubles et leur somme :

6

9 + 9

4

14

5 + 5

8

10

1 + 1

4 + 4

18

3 + 3

2

12

6 + 6

2 + 2

7 + 7

10 - Complète :

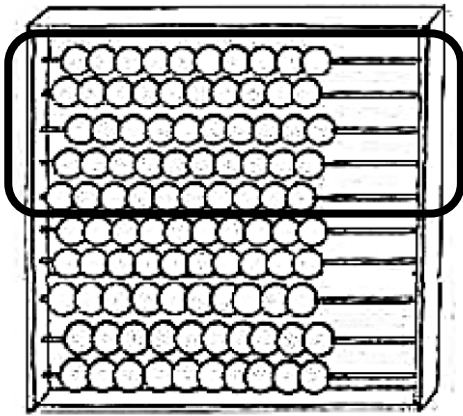

D	U
5	0

 ▶

dizaines = unités.

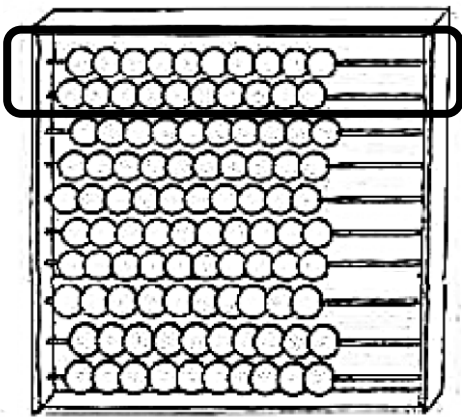

D	U

 ▶

dizaines = unités.

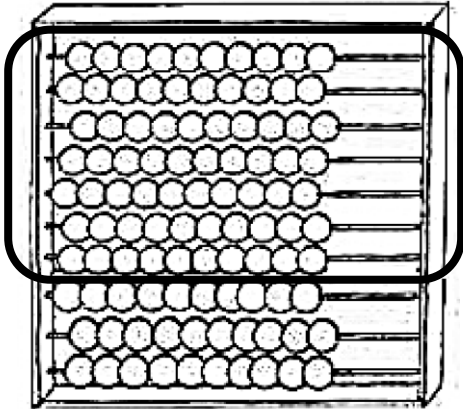

D	U

 ▶

dizaines = unités.

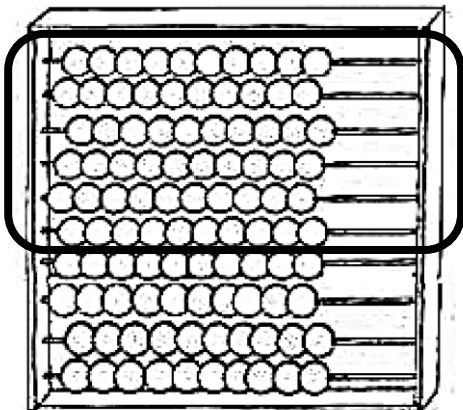

D	U

 ▶

dizaines = unités.

Points à relier

